

12" - 200W AlNiCo Guitar Loudspeaker

P12/100 BB- 8 Ω

Code ZJ06060

GENERAL CHARACTERISTICS

Nominal Overall Diameter	307	mm
Nominal Voice Coil Diameter	50	mm
Magnet Weight	826	g
Flux Density.....	1.00	T
Weight.....	3.23	Kg

THIELE-SMALL PARAMETERS

Voice Coil DC Resistance	R_E	6.30	Ω
Resonance Frequency	f_s	95.1	Hz
Mechanical Q Factor.....	Q_{MS}	11.81	
Electrical Q Factor.....	Q_{ES}	0.90	
Total Q Factor	Q_{TS}	0.84	
Mechanical Moving Mass	M_{MS}	27.7	g
Mechanical Compliance	C_{MS}	102	μm/N
Force Factor	$B \times l$	10.76	Wb/m
Equivalent Acoustic Volume.....	V_{AS}	34.4	lt.
Maximum Linear Displacement	X_{MAX}	+/-1.0	mm
Reference Efficiency	η_0	3.13	%
Diaphragm Area	S_D	490.8	cm ²
Losses Electrical Resistance.....	R_{ES}	82.7	Ω
Voice Coil Inductance @ 1kHz	L_E	0.59	mH

CONSTRUCTIVE CHARACTERISTICS

Magnet.....	AlNiCo
Voice Coil Winding.....	Aluminium
Voice Coil Former.....	Kapton
Cone	Paper
Surround.....	Paper - Integrated
Dust Dome	Non Treated Cloth
Basket	Pressed Sheet Steel

ELECTRICAL CHARACTERISTICS

Nominal Impedance.....	8	Ω
Musical Power	200	W
Rated Power*	100	W
Sensitivity @ 1 W, 1 m	98.0	dB

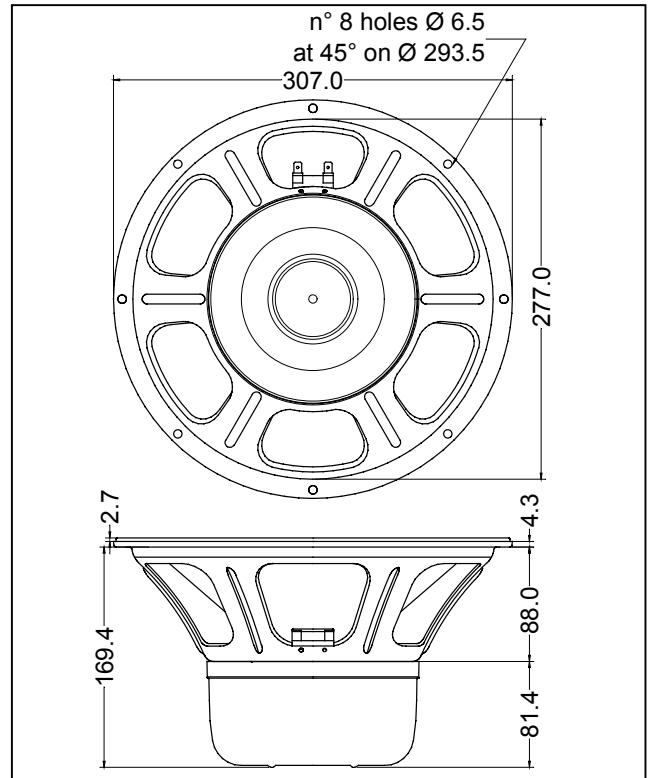

*rated power measured with 2 hours test with pink noise signal, 6 dB crest factor, loudspeaker mounted on enclosure

Frequency Response on IEC Baffle (DIN 45575) @ 1 W, 1 m - Impedance

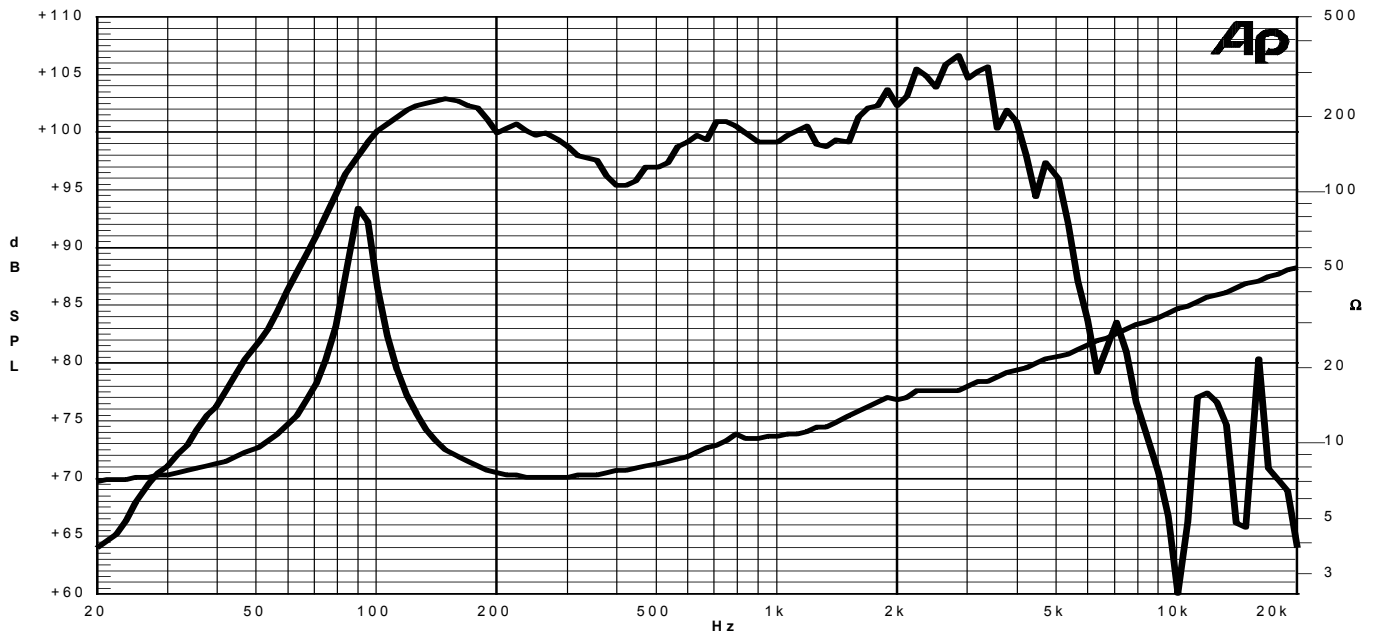

Due to continuing product improvement, the features and the design are subject to change without notice.

22/08/06